

Multiple Pig Launching System

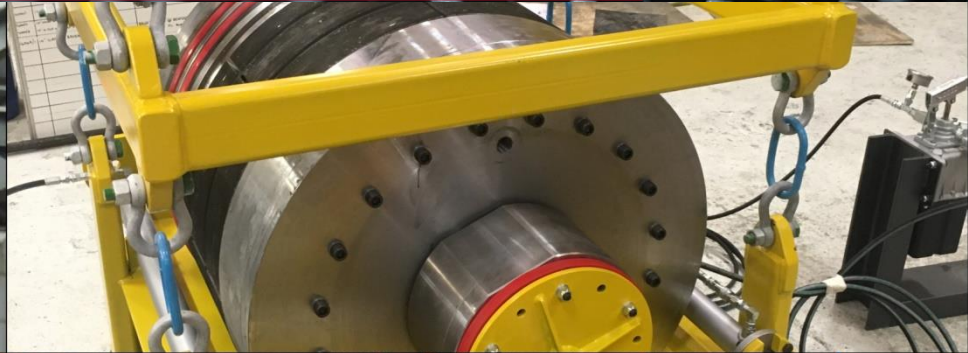
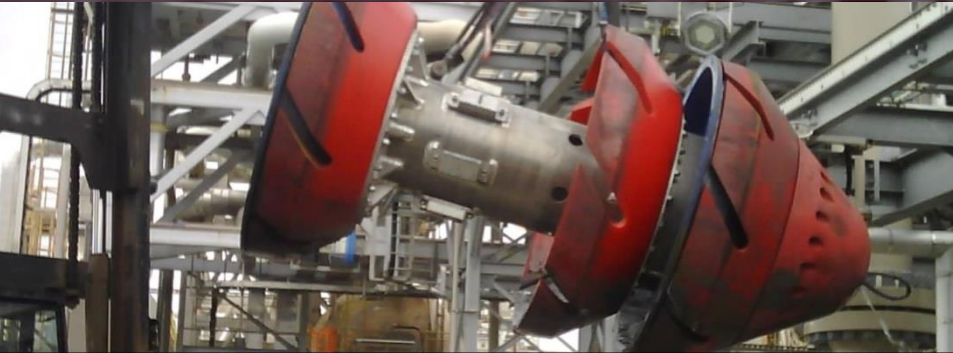

Pigging Products

Pigging Services

Hire/Rental

Solutions



iNPIPE
PRODUCTS



www.inpipeproducts.com

Multiple Pig Launching System

Presented by:

Rob Harrison; Technical Manager

Peter Fretwell; Consultant

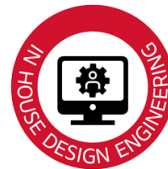

Multiple Pig Launching System

- **Brief Introduction to INPIPE PRODUCTS™**
- Multiple Pig Launching System [MPLS]
 - Background
 - Current systems
 - INPIPE PRODUCTS™ Solution
 - Design Development
 - CFD Analysis
 - Prototype Build
 - Testing
 - Conclusion

Multiple Pig Launching System

- **Brief Introduction to INPIPE PRODUCTS™**

- Established in 1984, over 35 years design & manufacturing experience:
Brompton On Swale North Yorkshire – Head Office, Design and Manufacturing facility
Aberdeen Service Centre – Refurbishment, Hire

Pipeline Pigs



Signallers

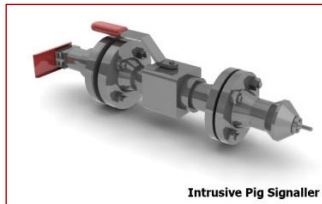

Isolation Plugs



Special Products

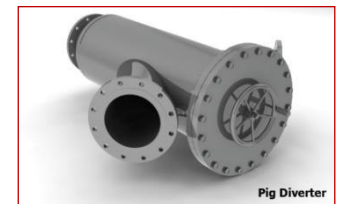

Design & Manufacture Bespoke Solutions



Pigging Equipment Management



Mechanical Debris Removal Solutions



Multiple Pig Launching System

- **Background**

Pigging is part of routine pipeline operations to ensure flow assurance.

In order to introduce a pig into a pipeline, typically a pig launcher is fitted to the pipeline.

Multiple Pig Launching System

- **Background, Conventional Pig Launching**

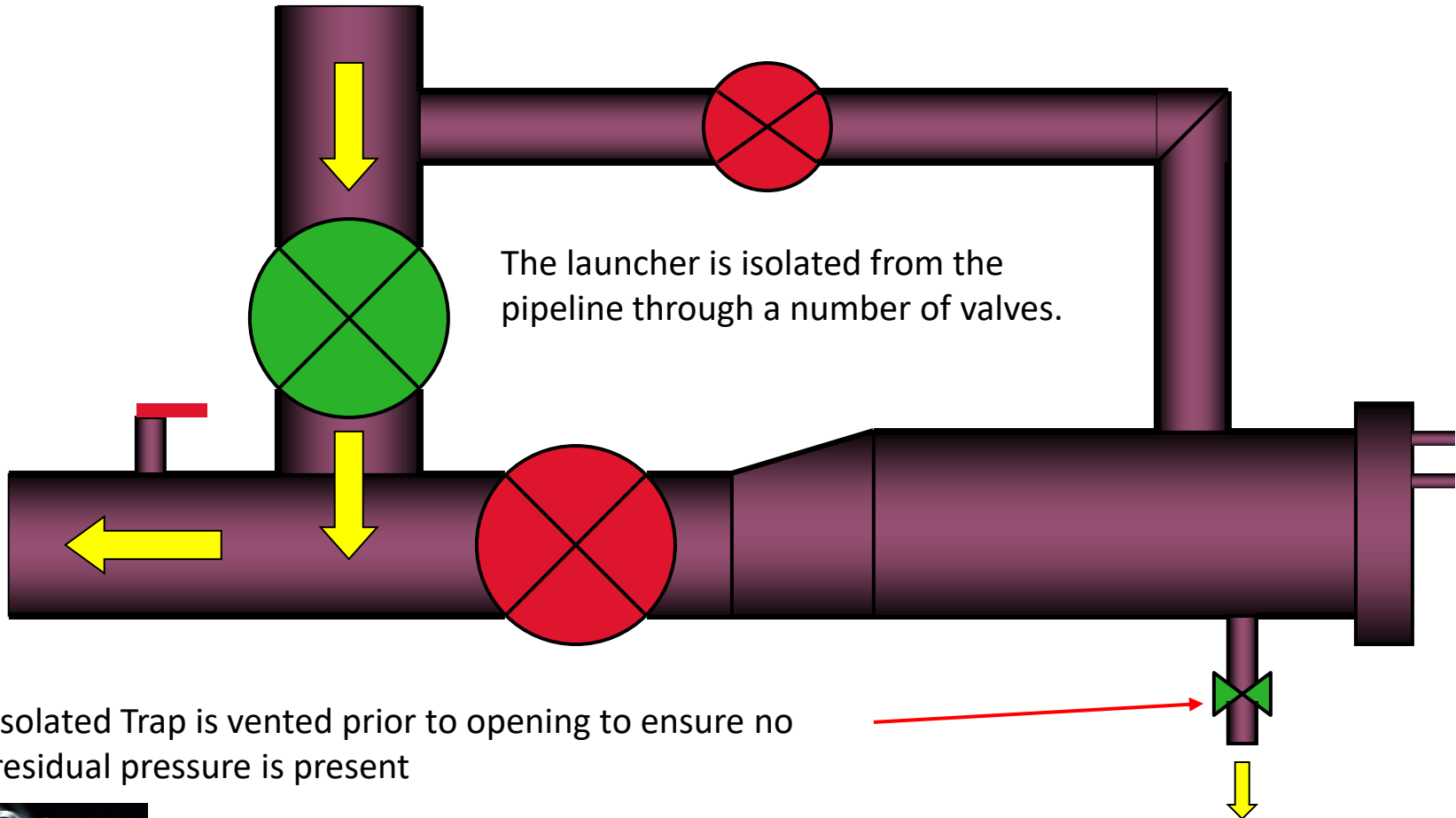

Isolated Trap is vented prior to opening to ensure no residual pressure is present

Multiple Pig Launching System

- **Background, Conventional Pig Launching**

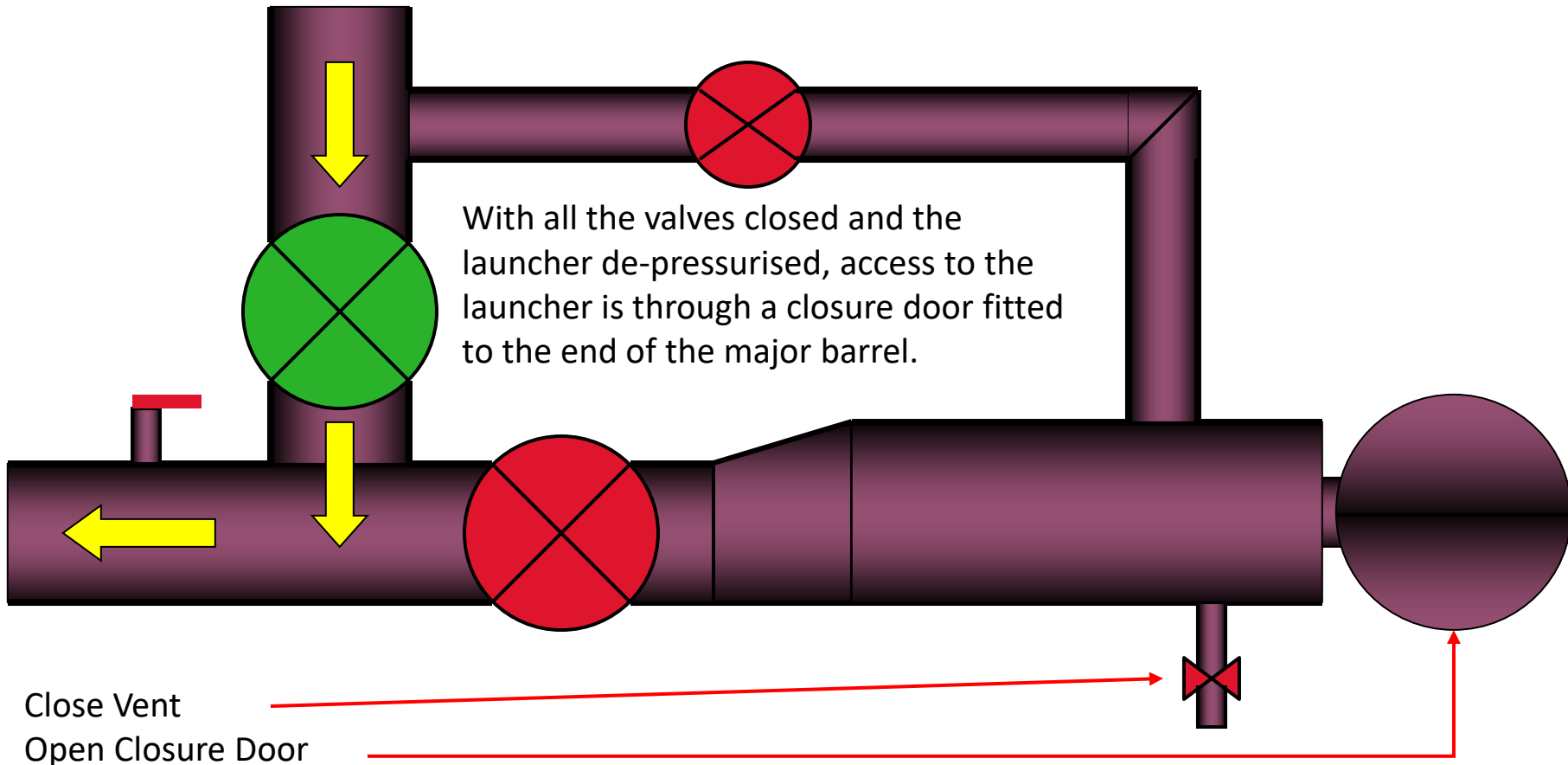

Multiple Pig Launching System

- **Background - Conventional Pig Launching**

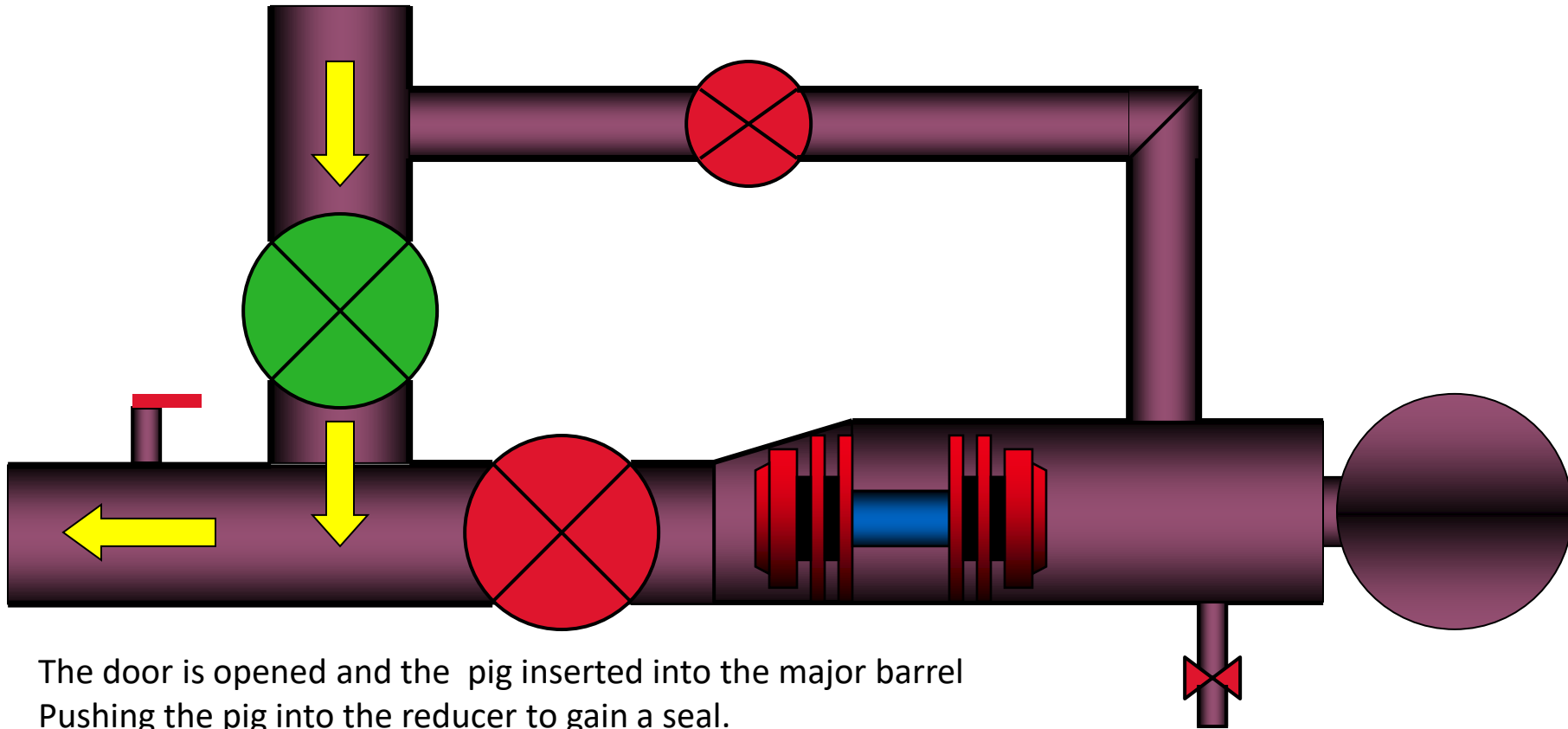

The door is opened and the pig inserted into the major barrel
Pushing the pig into the reducer to gain a seal.

Multiple Pig Launching System

- Background - Conventional Pig Launching

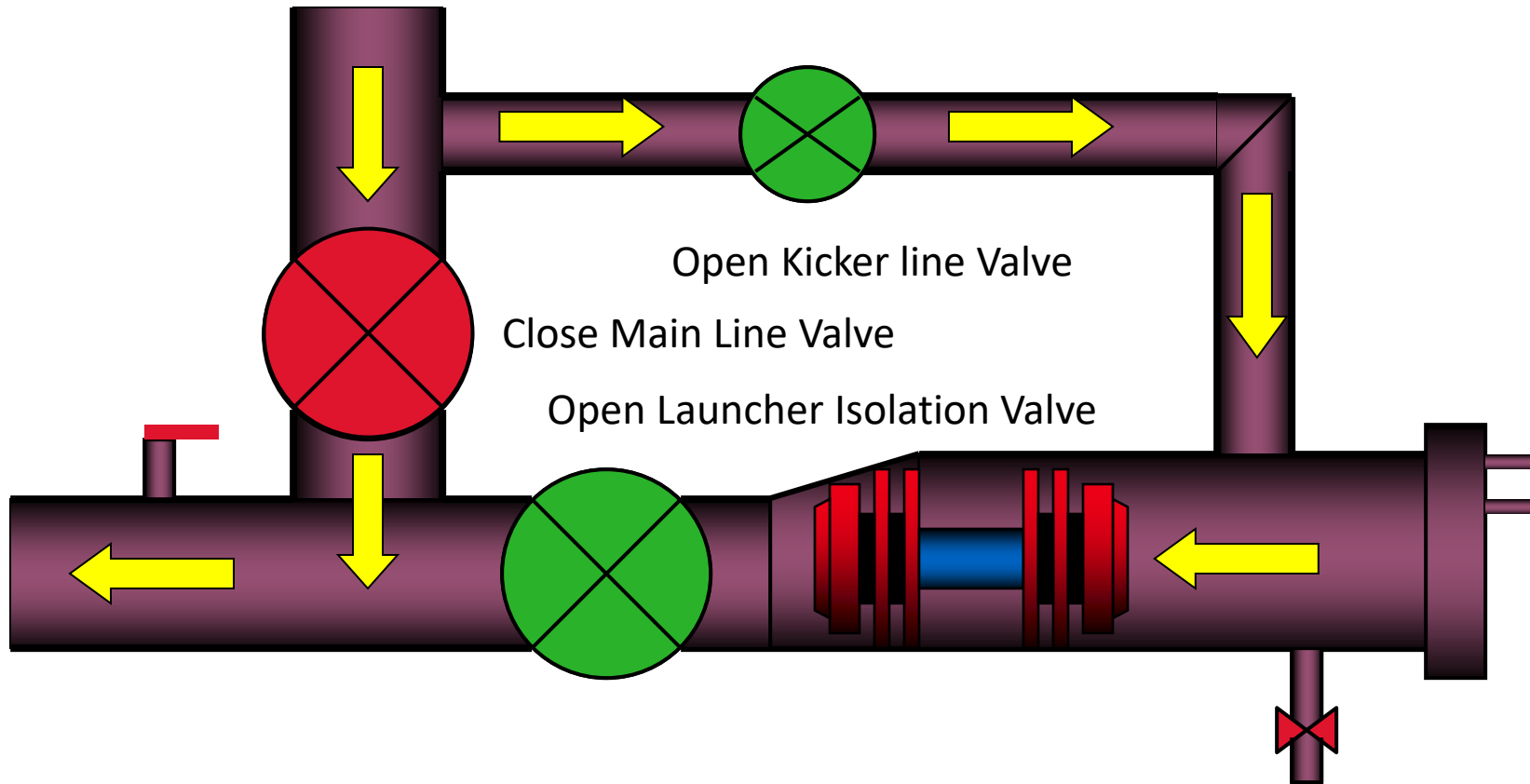

Multiple Pig Launching System

- **Background, Conventional Pig Launching**

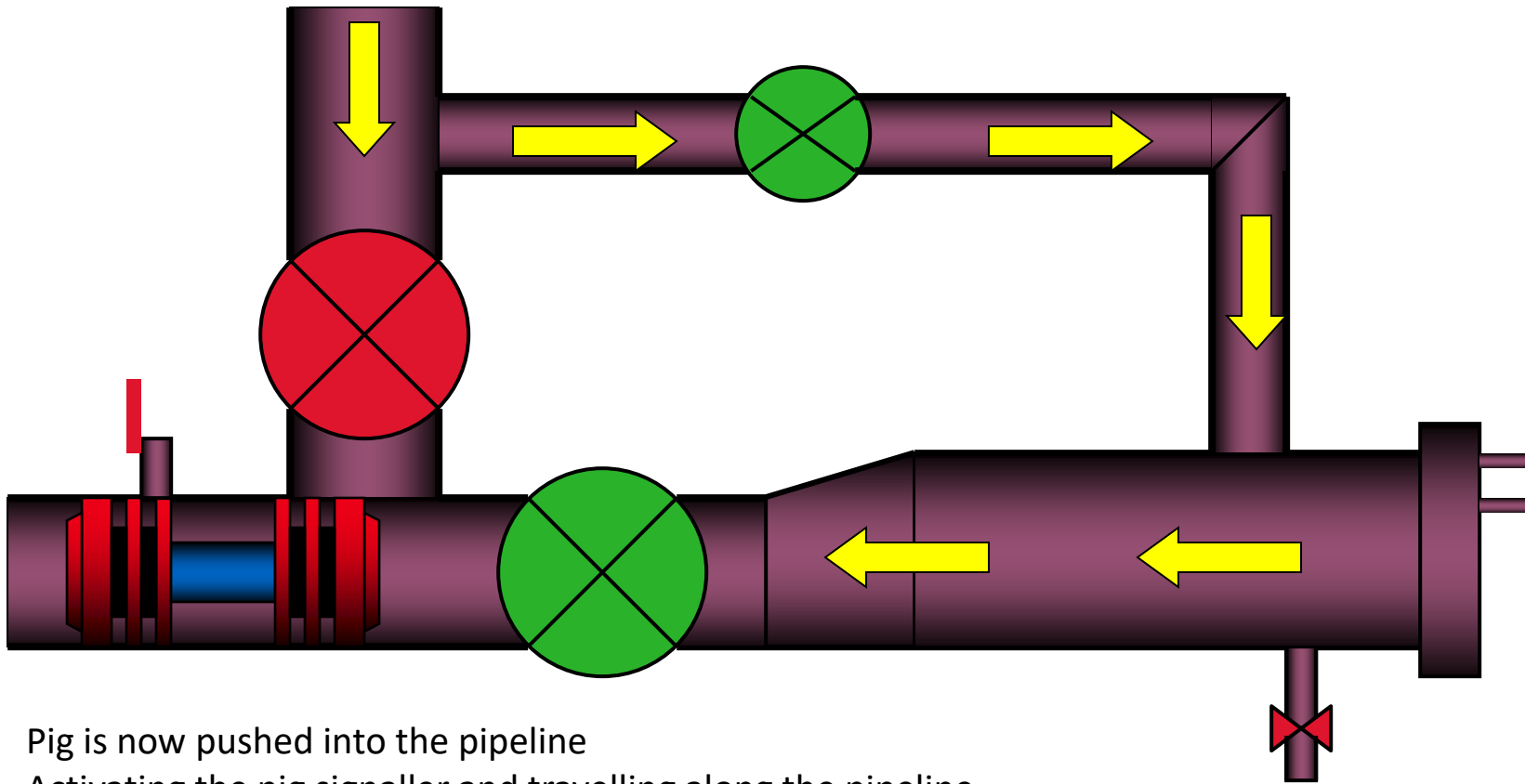

Pig is now pushed into the pipeline
Activating the pig signaller and travelling along the pipeline

Multiple Pig Launching System

- **Background**

Should a problem exist with the mainline isolation valve, for example not fully closing then this presents a problem in access to the launcher by opening the closure door as hydrocarbons are passing the valve and entering the launcher.

Opening the closure door allows these hydrocarbons to escape to atmosphere.

A decision must then be made as to shut the system down to allow pig loading operations to commence.

This can have huge financial implications in lost revenue in the time taken to shut down and then re-pressurise the pipeline.

Multiple Pig Launching System

- **Background**

This example exists for one particular client who were pigging a 36”ns gas pipeline weekly.

With an aging asset, a fault developed on the mainline isolation valve and every time a pig was required to be launched the ESD valve had to be operated, resulting in a days lost production at approximately £750K.

The client contacted INPIPE PRODUCTS™ in 2018 to request if they could help by providing a solution that would reduce the number of times in a year that the ESD valve had to be operated.

In short could more pigs be installed in the launcher and still have the ability to launch them individually?

Multiple Pig Launching System

- **Current systems**

Existing Multiple Pig Launching Systems [MPLS] designs currently or previously marketed, fall into two categories. Either relying on specifically designed launchers or complex valve arrangements built into the pigs.

Pig launcher fitted with fingers and valve arrangement. The pig launcher comprises of a number of nozzles fitted with a pig/sphere fingers and valve arrangement.

Using a conventional launcher the pigs are fitted with a valve that is held open creating bypass through the pig. This is held open by the pig directly in front. As the lead pig is launched the valve on the trailing pig closes thus allowing it to be driven forward.

To cut down on costs & mitigate the need for structural modifications to the old launcher, could a solution be developed that utilised existing infrastructure and existing pigs.

Multiple Pig Launching System

- **iNPIPE PRODUCTS™ Innovative Solution**

The idea. Using a cassette within the major barrel and using the existing drain nozzles to move the pigs forward until the kicker line takes over.

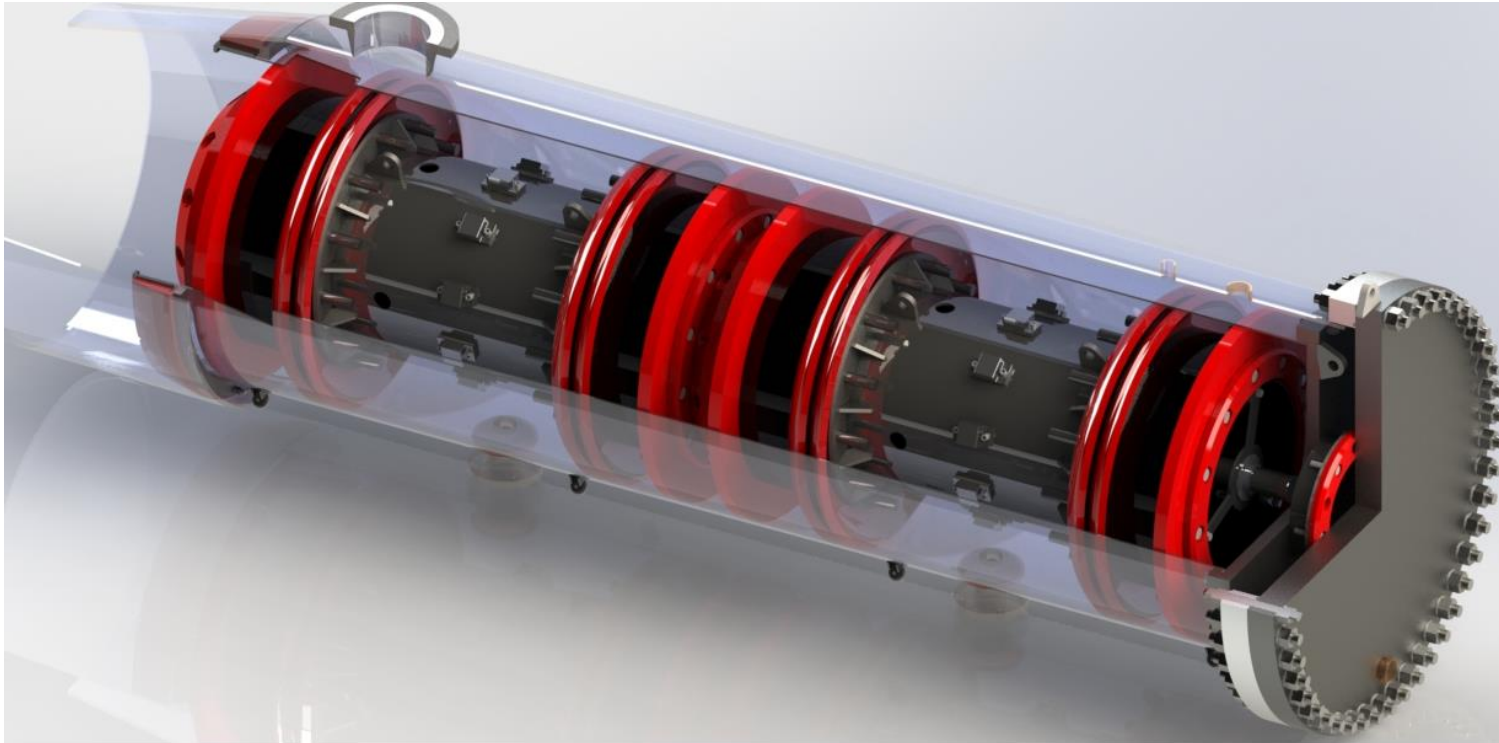

Multiple Pig Launching System

- **Design Development**

A seal was required that would self-energise when the pressure entered the seal from the nozzle

Example Closure door seal



Multiple Pig Launching System

- **Design Development**

Seal has to energise in three dimensions

Concept seal (Mushroom Seal)

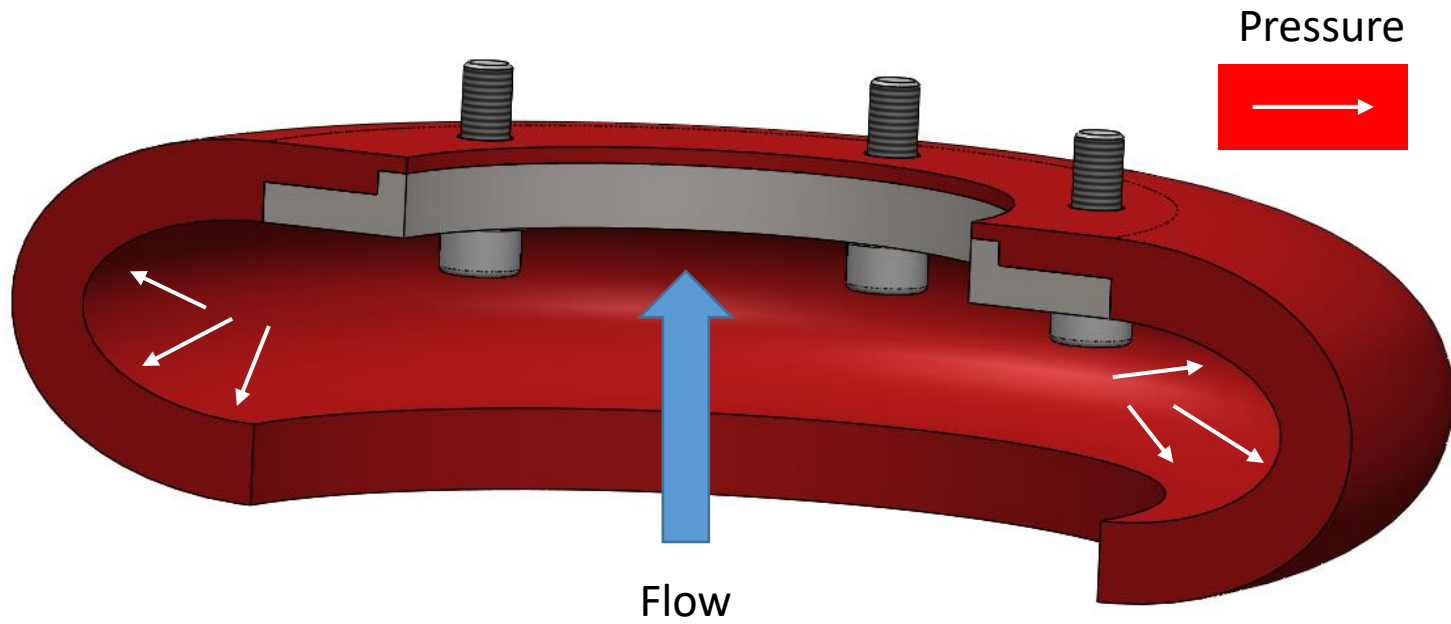

Multiple Pig Launching System

- **Design Development**

Testing the Concept seal

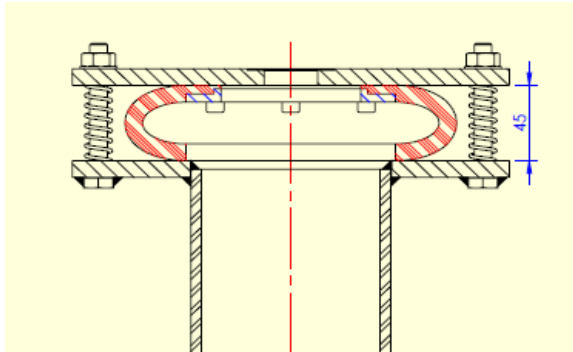

Testing conducted overnight.
In reality pressure holding
requirement would be no more
than 10 minutes.

Multiple Pig Launching System

■ CFD Analysis

Run in parallel to the seal development.

Executed as this would save costs in building a full scale prototype to then find that a pig could not be launched.

Required in depth meetings with the chosen supplier so they could understand how a pig interacted with a pipeline, data requested:

- Friction factors
- Pipeline Medium
- Pressure & Flow

Additional client question, “on launching the first pig would a vacuum or turbulence be created which would in turn cause the second pig to inadvertently launch”

Conclusion:

First pig would successfully launch with negligible movement of the second pig.

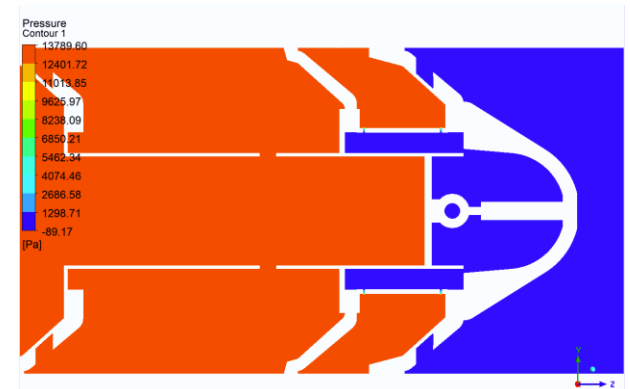

Pressure Contours

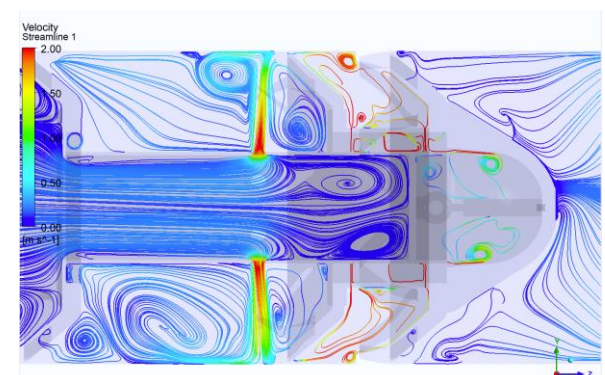

Velocity Streams

Multiple Pig Launching System

- **Prototype Build**

Existing test rig modified to mimic the launcher offshore, adding kicker line, and nozzles. Cassette to hold two full scale 36" production pigs fabricated in house.

Test rig assembled to enable testing firstly with water then re-configured to allow testing with a gaseous medium (compressed air)

FAT procedure and Risk Assessment developed with the client to allow a safe testing method.



Multiple Pig Launching System

- **Concept Proof Testing**

From the safety aspect testing would initially be conducted using water, however the pipeline transports gas so a true comparison would be to conduct a test using compressed air. Prior to testing the test rig was hydro-tested to 15 Barg to ensure pressure containment.

Tests to be carried out:

Loading of Pigs into Cassette

Loading of Cassette into Launcher

Validation of Launching Pig #1 – With Water

Validation of Launching Pig #2 – With Water

Validation of Launching Pig #1 – With Air

Validation of Launching Pig #2 – With Air

Multiple Pig Launching System

- **Concept Proof Testing**

Loading of Pigs into Cassette

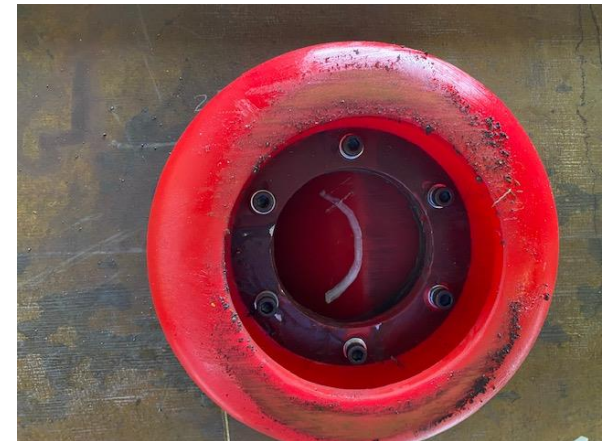

Multiple Pig Launching System

- **Concept Proof Testing**

Loading of Cassette into Launcher

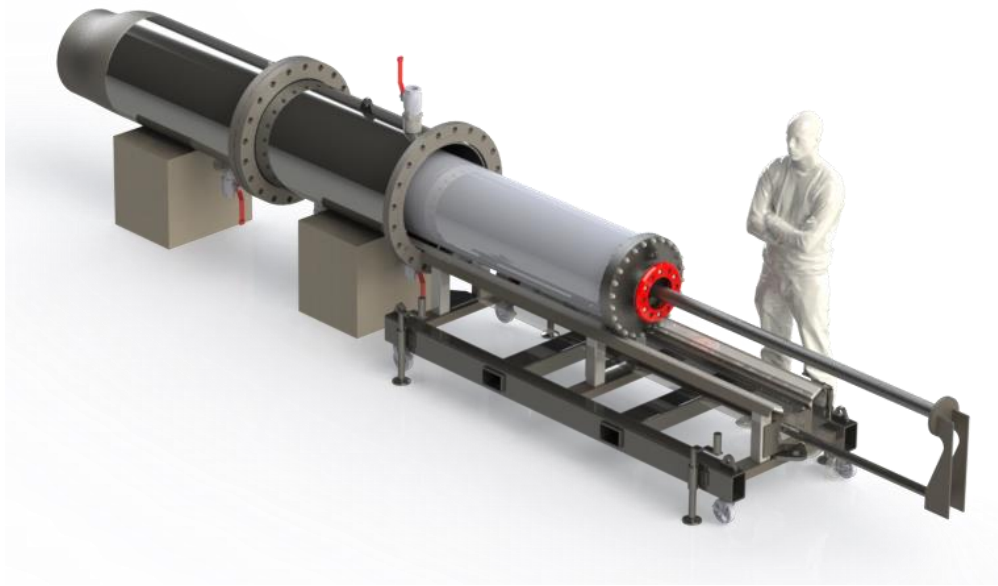

Multiple Pig Launching System

- **Concept Proof Testing**

Validation of Launching Pig #1 – With Water

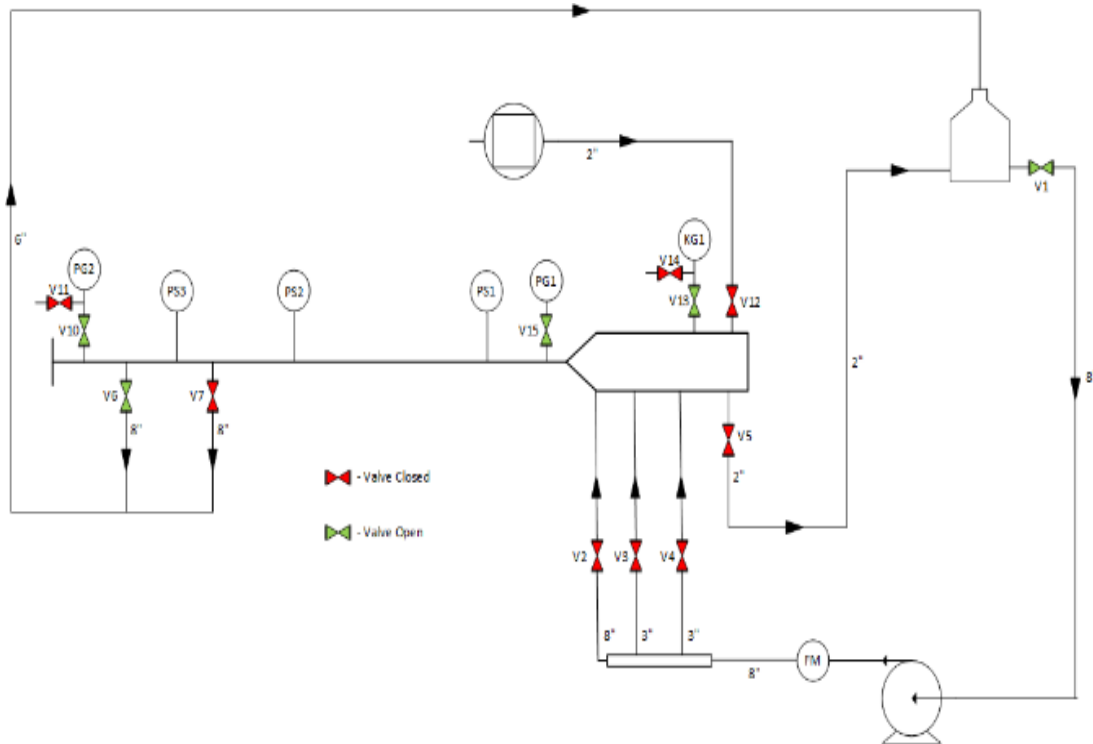

Multiple Pig Launching System

- **Concept Proof Testing**

Validation of Launching Pig #1 – With Water

Water pumped into the test rig to launch the 1st pig. However, after running the pump for a few minutes it was clear that the Pig #1 had not launched. Agreed to stop the test and investigate into why Pig #1 had not launched.

Cassette removed and it was found that Pig #1 had initially launched but had stalled due to bypass, through the bypass slots in the cassette and over the front cup, as the front cup had straddled the slots in the cassette.

Once the cassette had been removed and the cause of the stalling pig could be clearly seen. It was agreed that the pig should be reconfigured with an additional sealing disc behind cup #2, which would maintain drive as the front cup passed over the slots.

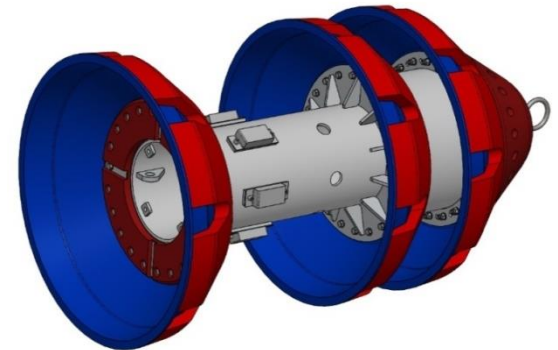

Multiple Pig Launching System

- **Concept Proof Testing**

From the recorded data, shown in Graph 1, it can be seen that Pig #1 launched with a DP of 0.7Bar & Pig #2 launched with a DP of 0.7Bar.

Test was concluded as a success and stopped.
Test rig was then reconfigured for Air Pigging.



Graph 1: Water Pig Run #1 & #2

Multiple Pig Launching System

■ Concept Proof Testing

Validation of Launching Pig #1 – With Air

The testing spread was reconfigured with 2 off 10bar (restricted to 7Bar) 750scfm compressors delivering a combined flow of 1500scfm.

The pigs, reloaded into the cassette and the cassette then loaded into the launcher.

The test was started with both compressors delivering max air flow of ~1500scfm.

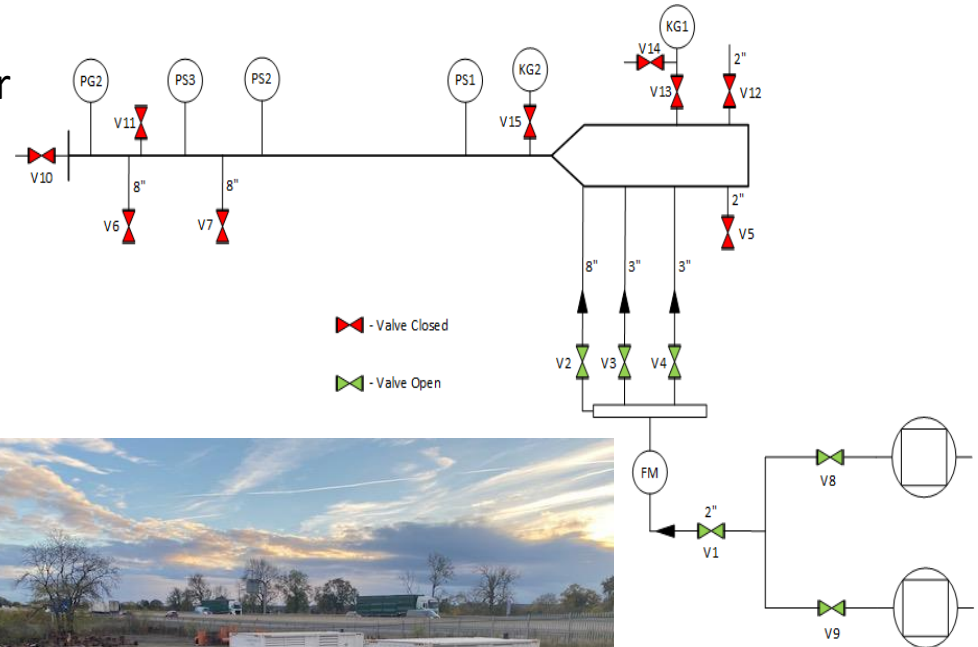

Multiple Pig Launching System

- **Concept Proof Testing**

The test rig pressure was increased and equalised to 4Bar and then locked in.

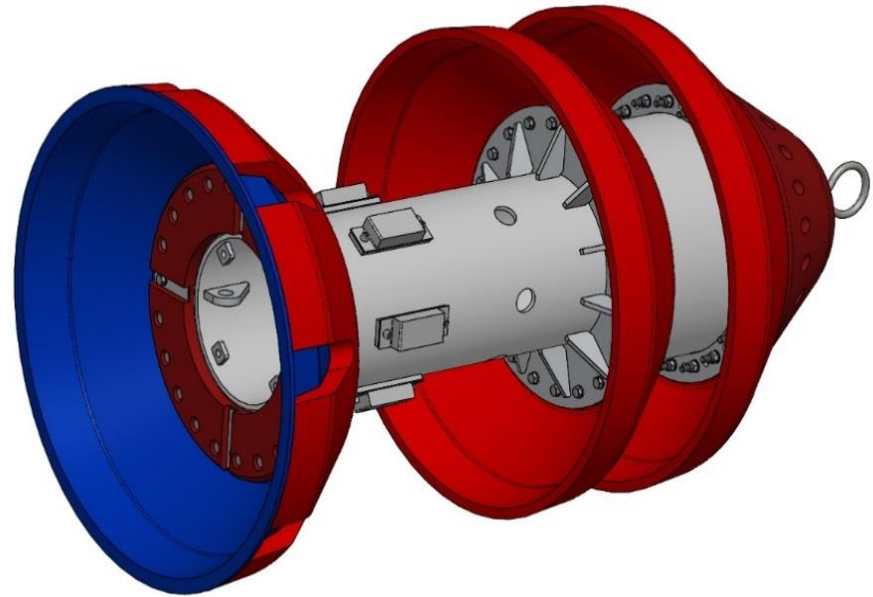
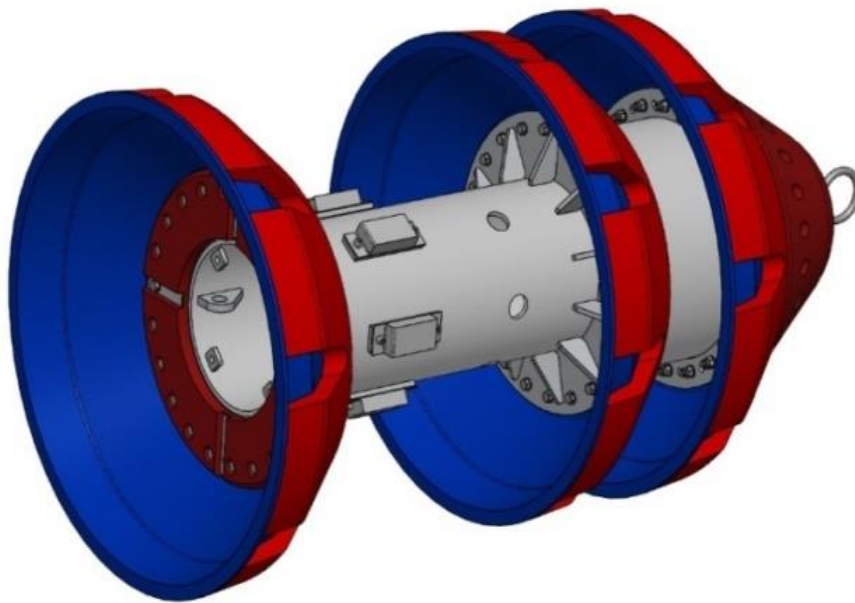

Blue seal discs had buckled not creating a good seal and resulting in failure to launch the pig #1.
For testing to continue the front 2 cups & seals on each pig would be replaced with solid cups,
creating a better seal.

Multiple Pig Launching System

■ Testing

Test was started with a single compressor delivering ~750scfm.

Air was injected, test rig pressure increased and equalised to 4Bar and then locked in.

Delivery valve was opened and test conducted, but resulted in a failed launch. 2nd compressor was started to inject air at 1500scfm.

Process repeated a number of times but pig failed to launch each time.

It was agreed to stop the test and remove the cassette to observe any pig movement.

Upon removal of the cassette it could be seen that Pig #1 had indeed initially launched but had stalled as it exited the cassette.

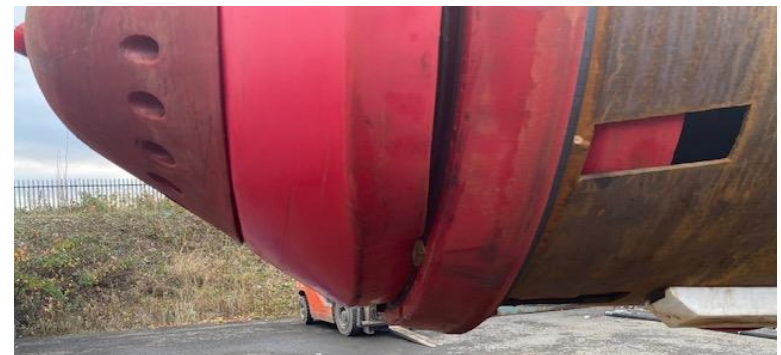

Multiple Pig Launching System

- **Testing**

After further review it was agreed that the slots in the cassette should be reduced in length by 50% but additional slots created to maintain the same area volume for the air flow.



Cassette modifications were completed. Pigs were loaded into the cassette, which was then loaded into the launcher, and the test repeated. Test was carried out with a successful independent launch of Pig #1 & Pig #2.

Multiple Pig Launching System

- Testing

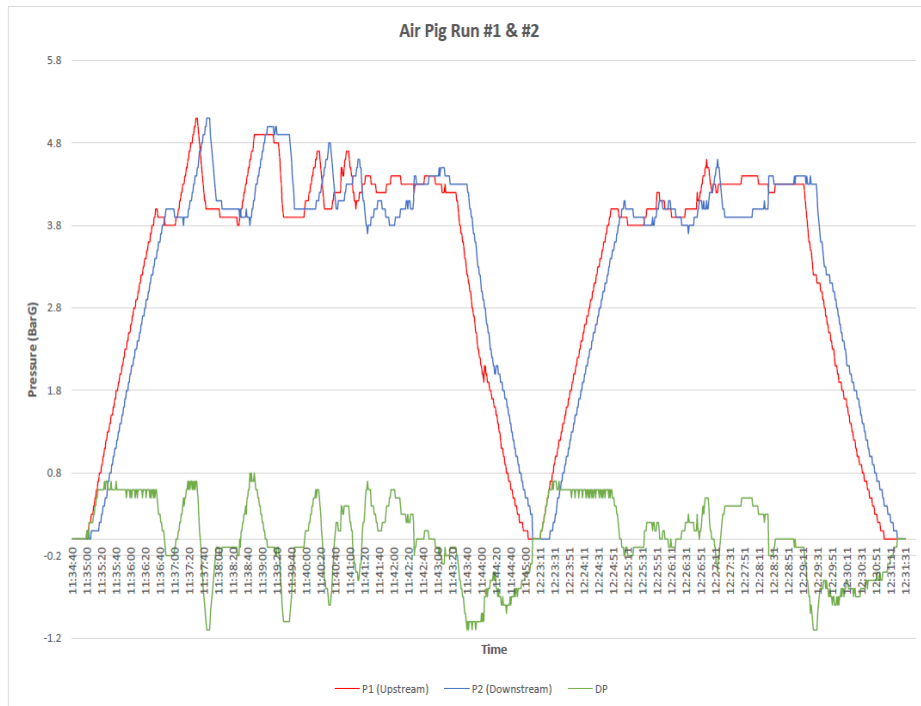

Pig #1 was launched and once traversed through the test rig the test was stopped.

Test rig depressurised and Pig #1 removed. Upon removal of Pig #1, the test rig was sealed and the test repeated to launch Pig #2, as per the procedure.

Pig #2 was launched and once traversed through the test rig the test was stopped and the test rig depressurised and Pig #2 removed.

Depressurisation of the test rig simulated the offshore trap isolation and depressurisation activity between pig launches.

From the data shown in the graph it can be seen that Pig #1 launched with a DP 0.7Bar increasing to a max DP of 0.8Bar and then Pig #2 launched independently with a DP of 0.7Bar.

This completed the testing.

Multiple Pig Launching System

■ Conclusion

From the testing results it can be concluded that the design and functionality of the Mushroom Seal and the cassette have been verified and confirmed that independent launches of the Pig #1 & Pig #2 can be achieved. The important actions to take away from the testing are as follows:

- Pig configuration to be confirmed – Final testing was conducted on a reconfigured Operational Pig with 2 off front solid cups.
- Design of the Cassette – The position of the slots in relation to the pig exiting the cassette and maintaining a seal needs to be engineered correctly for the operational cassettes.
- Pigs launch confirmed with a flow rate of ~750scfm through the 3” Injection line, flow needs to be introduced via the 8” Kicker Line to maintain pig movement through the pipeline.

iNPIPE PRODUCTS™ offers the latest in cutting edge technology, with design and manufacturing capabilities in-house.

iNPIPE PRODUCTS™ facilities allow for the manufacture and production of both standard and customised products, with turning and forming machinery for the production of high quality machined parts.

iNPIPE PRODUCTS™ places emphasis on providing client-led solutions and offering a full advisory service.

iNPIPE PRODUCTS™ provides an unrivalled product range that includes Metal Bodied Pigs/Scrapers, Foam Pigs, Spheres, Weld Testers, Pig Signallers as well as Launching and Receiving hardware. We are world leaders in the design and manufacture of pigging, pipeline pigging and pigging components.



iNPIPE
PRODUCTS

Gatherley Road, Brompton on Swale, North Yorkshire, DL10 7JH

Tel: +44 (0)1748 813270

Fax: +44 (0)1748 813454

sales@inpipeproducts.co.uk

www.inpipeproducts.com

